

ERGOFIT

Owners Manual

IMPORTANT: PLEASE READ THIS
MANUAL BEFORE USING YOUR
ERGOFIT LIFEJACKET



BS EN ISO 12402-3:
2006+A1:2010

190N LIFEJACKETS



BS EN ISO 12402-2:
2006

290N LIFEJACKETS





150N LIFEJACKETS

This level 150N lifejacket will give a reasonable assurance of safety from drowning to a person who, for whatever reason, is no longer capable of helping themselves fully. This level is intended for general application or for use with foul weather clothing. It will turn an unconscious person into a safe position and requires no subsequent action by the user to maintain this position. This jacket is suitable for offshore use.



BS EN ISO 12402-3:
2006+A1:2010



275N LIFEJACKETS

This level 275N lifejacket is intended primarily for offshore use under extreme conditions. It is also of value to those who are wearing clothing that traps air and which may adversely affect the self righting capacity of the lifejacket. It is designed to ensure the user is floating in the correct position with their mouth and nose clear of the surface.



BS EN ISO 12402-2:
2006

IMPORTANT INFORMATION

- Train yourself in the use of this device

ERGOFIT

Introduction To Lifejackets

ErgoFit Lifejacket Range & Features.....Page 4

Lifejacket Donning

Donning the ErgoFit 190N ProPage 6

Donning the ErgoFit 190N OSPage 7

Donning the ErgoFit 290N OCPage 8

Donning the ErgoFit 290N EX..... Page 9

Lifejacket Inflation Methods

Know Your Inflation Mechanism Type Page 10

Re-Arming Pro-Sensor Operating Mechanisms.....Page 11

Re-Arming Hammar Operating Mechanisms..... Page 12

Lifejacket Features & Packing

Unpacking the ErgoFit Lifejacket.....Page 13

ErgoFit 190N Pro & OS RepackingPage 14

ErgoFit 290N OC RepackingPage 19

ErgoFit 290N EX RepackingPage 23

Care & Maintenance

General Care & Maintenance Page 26

Cleaning, Storing & Other Important InformationPage 28

Testing Your Lifejacket

Testing Your LifejacketPage 29

Using the Inflation Tube on Inflatable Lifejackets.....Page 31

Other Information

Using Safety Lines with a Harness LifejacketPage 32

Using Spray Hoods.....Page 33

Correct use of Lifting Beckets..... Page 33

Warranty & Servicing..... Page 34

ERGOFIT 290^{OC}

DONNING THE ERGOFIT 290N OC LIFEJACKET

- 1 & 2 Don like a normal jacket
- 3 Fasten front buckle
- 4 Adjust waist belt by pulling webbing forward for a close secure fit
- 5 Fasten crotch strap buckles and adjust straps by pulling webbing downwards for a close secure fit
- 6 Tidy crotch straps by rolling excess webbing and securing with velcro tab
- 7 To release straps, pull the release tabs attached to the adjustment buckles

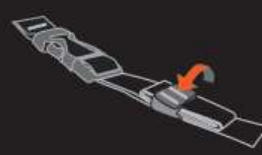
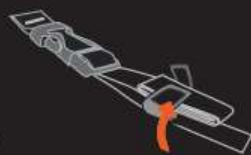
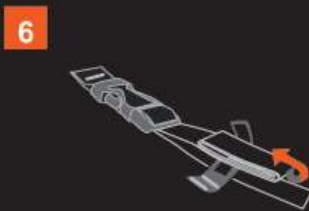
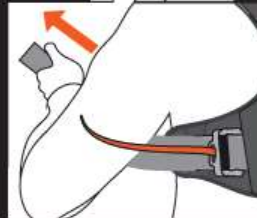
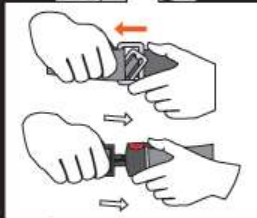

KNOW YOUR INFLATION MECHANISM TYPE

PRO-SENSOR MK3: AUTOMATIC OR MANUAL

- 1 (AUTOMATIC ONLY) Check that the automatic firing capsule (C) is screwed fully onto the operating mechanism (B). Ensure that the capsule (C) has not been fired inadvertently by checking that the bottom indicator shows green (D). Also check the expiry date on the side of the capsule. Do not use a capsule that is out of date.
- 2 Check the CO₂ cylinder (A) is securely screwed into the operating mechanism. Check that the top indicator (D) shows green.
- 3 Ensure pull handle (E) is located in the garages in the jacket cover and cord is not tangled or damaged.

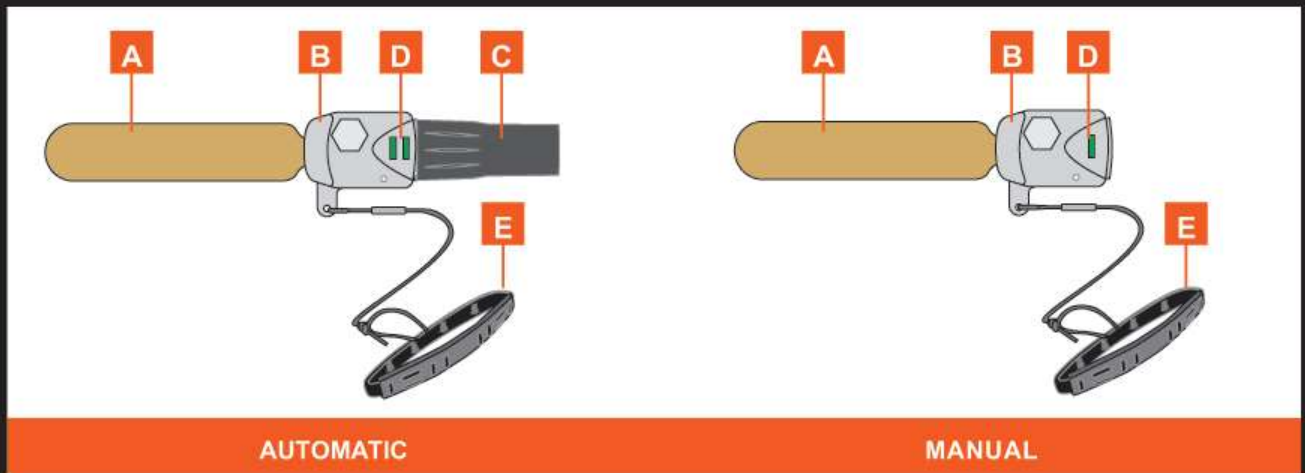

HAMMAR AUTOMATIC

- 1 Check that the indicator on the cap is green (D) that the pull to inflate lanyard (E) is present and that the locking ring (C) is locked. When the locking ring is locked (C) it cannot be turned counter clockwise by hand. Check the expiry date on the front of the cap (B). Do not use a cap that is out of date.
- 2 Check the CO₂ cylinder (A) is securely screwed into the inflator body by feeling through the fabric.
- 3 Ensure pull handle (E) is located in the garages in the jacket cover and the cord is not tangled or damaged.



RE-ARMING PRO-SENSOR OPERATING MECHANISMS

Always re-arm your lifejacket ready for use before you stow it away. The operating mechanism must be thoroughly dried before re-arming. When re-arming your lifejacket it is important you use only Crewsaver supplied components. For your nearest supplier contact Crewsaver or see www.crewsaver.com

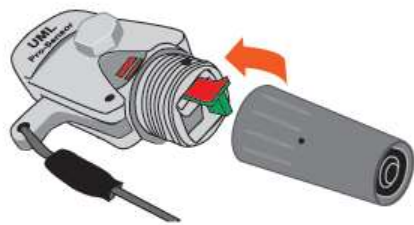

AUTOMATIC
On an automatic model, unscrew and remove the automatic capsule first

MANUAL

AUTOMATIC ONLY Take the new automatic firing capsule and screw onto the operating mechanism in a clockwise direction. Screw right up ensuring there is no gap between the capsule and the base of the operating mechanism. Do up hand tight. The bottom indicator will turn green when capsule is tightened correctly.

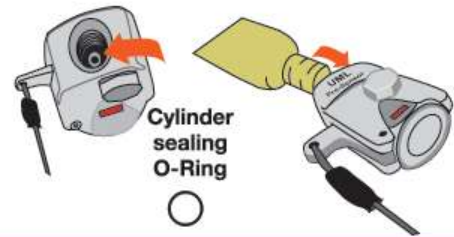
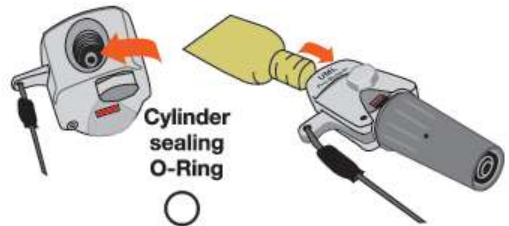

AUTOMATIC

MANUAL

Check that the cylinder-sealing gasket in the end of the operating mechanism has been correctly fitted, or replaced if necessary. Check the new CO₂ cylinder has not been used and screw into the main body in a clockwise direction. Ensure the cylinder is screwed right down and do up hand tight. The top indicator will turn green when cylinder is tightened correctly.

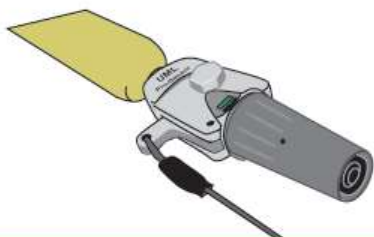

AUTOMATIC

MANUAL

The operating mechanism is now rearmed. Both Indicators should show green. Do not use if either indicator is red.

WARNING: If you are unsure or have any doubt how to re-arm and repack your lifejacket return the product to Crewsaver or your nearest Crewsaver service agent.

See more details on the UML Pro-Sensor Mk3 mechanism. www.uml.co.uk

RE-ARMING YOUR HAMMAR OPERATING HEAD



1 Place the lifejacket on a smooth, flat surface and wipe off any water. Hold the gas cylinder through the fabric, using one hand.



2 Insert metal key as shown in 2a and turn the key counter clockwise (2b) between black locking ring and labeled yellow cap. The black locking ring will now turn counter-clockwise.

3 Now turn back locking ring counter-clockwise (3a) and lift the cap off (3b).



4 Squeeze the sealing ring to elongate and remove the inflator body through. Dispose of the used inflator body in an environmentally approved manner.

5 Check that the indicator is green. Insert new inflator body with gas cylinder pointing upwards inside the lifejacket. Let the sealing ring rest on the inflator body around the four lugs.

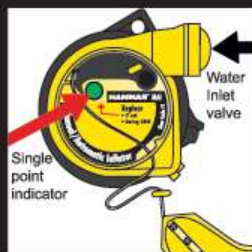

6 Now check the new manual/automatic cap as follows:
 1. Single point indicator is showing green
 2. Expiry date is in date

If YES is the answer to both these questions, then proceed as follows. If NO, then a new capsule is required.



7 Hold the gas cylinder through the fabric of the lifejacket (7a). Position the replacement cap with the water inlet valve pointing to the right (7b) and press it FIRMLY onto the inflator body and sealing ring.

8 While pressing FIRMLY onto the inflator body turn the black locking ring clockwise into the locked position. Pull on the cap to make sure it has locked onto the inflator body.



9 To see that the indicator on the cap is green; that the pull to inflate lanyard is present and that the locking ring is locked. (9a) When the locking ring is locked, it cannot be turned counterclockwise by hand. If your lifejacket has been used and/or the hammar inflator replaced, always inflate the jacket through the oral tube (9b) and check that it stays inflated at least overnight. If the lifejacket fails the inflation test contact your nearest Crewsaver service station for further check. Empty the lifejacket again by pushing in the non-return valve in the top of the oral tube and press out ALL RESIDUAL AIR from the bladder, so that the jacket may be folded properly. Let the lifejacket dry before packing. When not in use always store your lifejacket in dry and well ventilated space.

OPENING THE LIFEJACKET COVER



- 1 Open the velcro tab.
- 2 To avoid damaging your lifejacket zip, pull apart the zip, open the zip via the quick burst elements, holding the cover either side.
- 3 Once the zip has opened, insert your finger and slide it around the lifejacket. Undo the zip all the way around the outside of the lifejacket. The lifejacket cover should now be open and the inflation chamber visible. Fully separate the zip. Both sides of the zip should be apart, with the zip slider free to move back around the lifejacket to the start.

PREPARING ZIP FOR RE-PACKING

- 1 Ensure that the zip slider is separated on one side.
- 2 Slide the zip around to the right side of the jacket as worn.
- 3 Feed the zip teeth into the slider ready to re-pack.

To Open

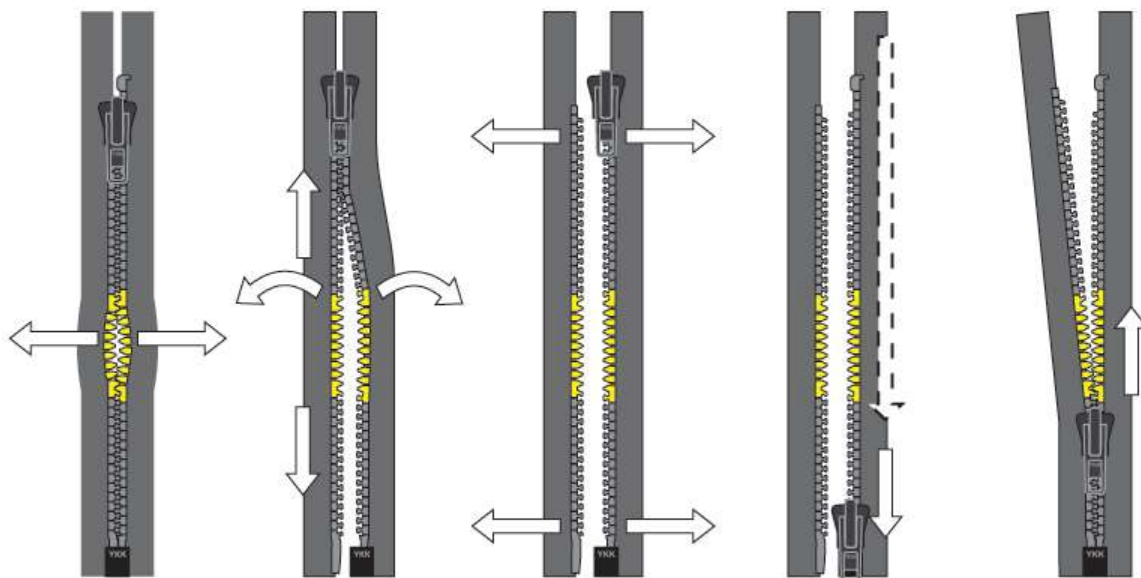

To Close

PRE REPACKING CHECKLIST - 290N OC LIFEJACKET

Ensure that your lifejacket is completely dry before packing.

(Refer to page 26 - Care and Maintenance for details on storing and cleaning your lifejacket)

- 1 Ensure hood-webbing is placed above chamber collar, and velcro tabs are secure.
- 2 Ensure pull cord handle is located in its garage on outer cover.
- 3 Ensure firing mechanism is armed correctly and green indicators are showing.
- 4 Lifting beackets should be firmly pressed onto press studs.
- 5 Fix light activator to its elastic retainer at the back of the collar.
- 6 EPIRB attachment. Please see www.crewsaver.com for details.

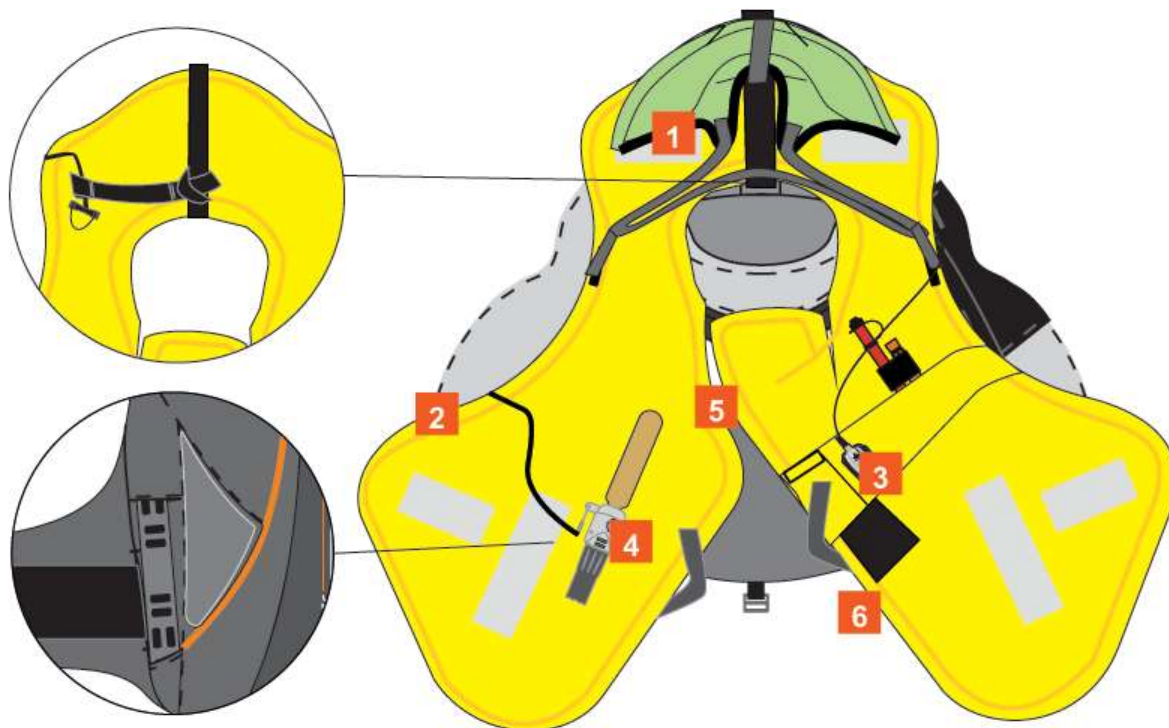

REPACKING THE SPRAYHOOD

- 1 Lay hood out so tubing lays flat and straight against the back of the chamber.
- 2 Gather tubing and excess visor up and secure with velcro retainers.
- 3 Affix velcro tabs on webbing to velcro retainers on chamber. Ensure webbing lays over the chamber collar.



REPACKING THE ERGOFIT 290N OC LIFEJACKET



WARNING: Ensure all air is expelled / removed prior to packing



- 1 Fold up bottom right side of chamber. Run the zip slider round to the left side.
- 2 Fold outer right side of chamber over towards the center.
- 3 Fold the inner edge of the chamber over towards the outside.
- 4 Fold back chin support and roll underneath folded chamber.
- 5 Fold over excess chamber bringing light to the top.
- 6 Concertina the collar with two folds. The hood should lie on top.
- 7 Fold top corners of collar down and tuck hood in. Take care not to tangle light cord or hood pull webbing.
- 8 Concertina bottom edge of chamber. Firing capsule should lie on top.
- 9 Fold outer edge of chamber in towards the centre.
- 10 Fold inner edge over as far as it will go.
- 11 Tuck cord away. Roll excess back on itself so the firing mechanism is on top.
- 12 Tuck everything inside the cover and close cover using zip from the left hand side, fixing velcro burst tabs as you go.
- 13 Tuck hood in. Take care not to tangle light cord or hood webbing.
- 14 Tuck zip ends inside cover so the bottom of the jacket looks neat. Ensure firing mechanism is visible through the window.

REPACKING YOUR LIFEJACKET

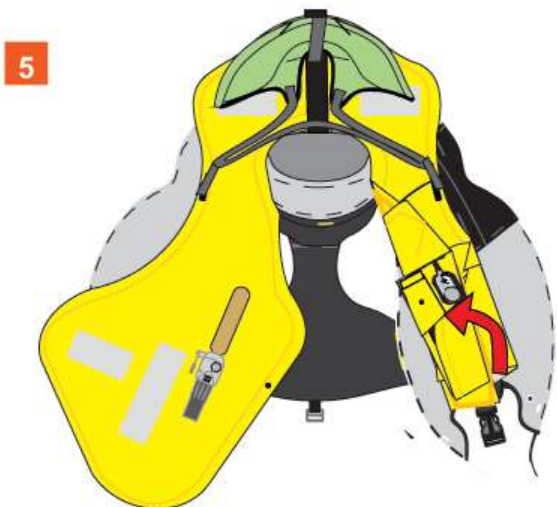
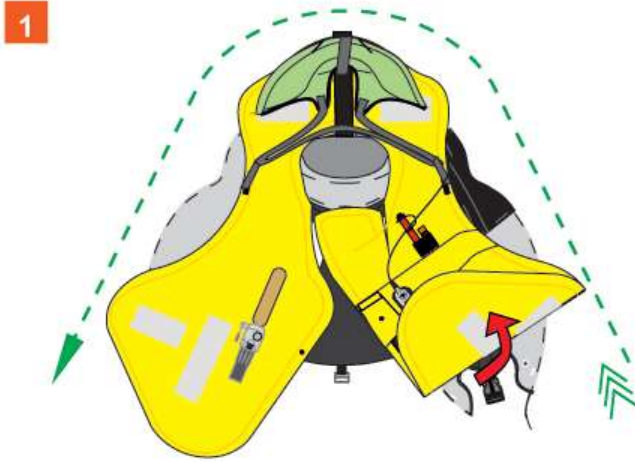

7



8



9



10



11

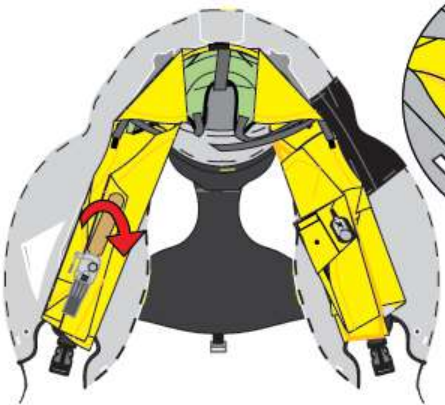

12



13



14



PRE REPACKING CHECKLIST - 290N EX LIFEJACKET

Ensure that your lifejacket is completely dry before packing.

(Refer to page 26 - Care and Maintenance for details on storing and cleaning your lifejacket)

- 1 Ensure hood webbing is placed above chamber collar, and velcro tabs are secured.
- 2 Ensure pull cord handle is located in its garage on outer cover.
- 3 Ensure firing mechanism is armed correctly and green indicators are showing.
- 4 Lifting beackets should be firmly pressed onto press studs.
- 5 Fix light activator to its elastic retainer at the back of the collar.
- 6 EPIRB attachment. Please see www.crewsaver.com for details.

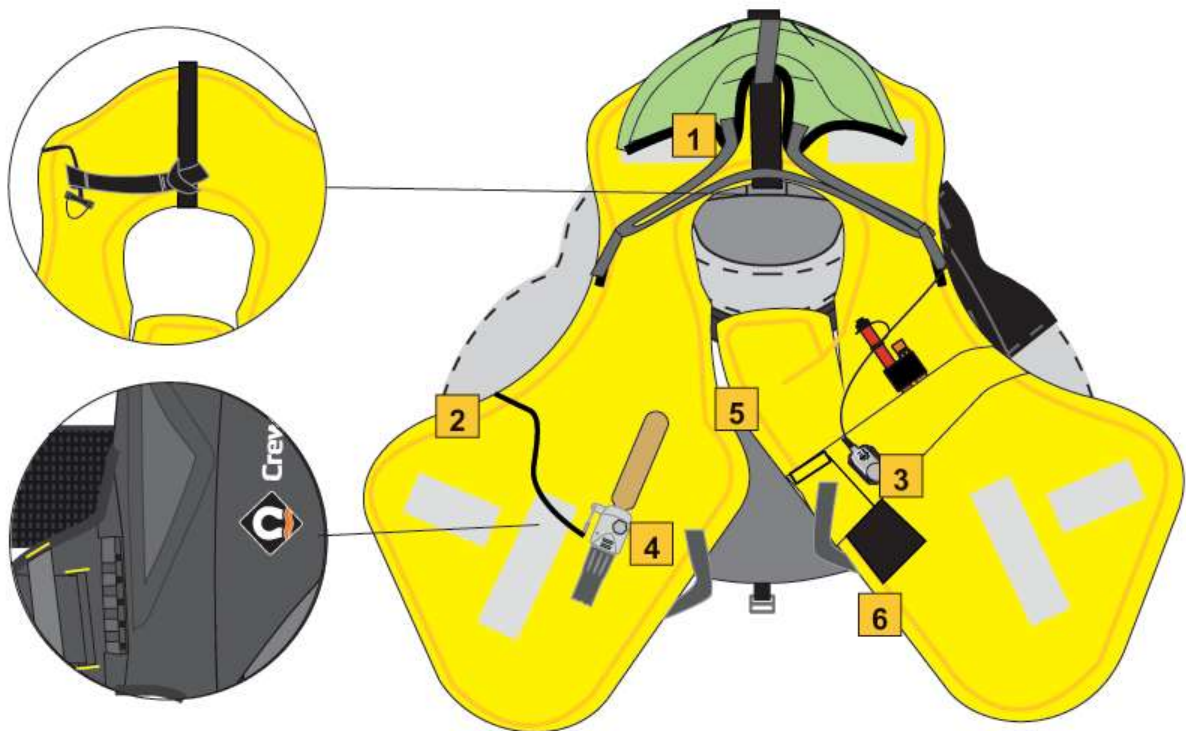

REPACKING THE SPRAYHOOD

- 1 Lay hood out so tubing lays flat and straight against the back of the chamber.
- 2 Gather tubing and excess visor up and secure with velcro retainers.
- 3 Affix velcro tabs on webbing to velcro retainers on chamber. Ensure webbing puller lays over the chamber collar.



CARE & MAINTENANCE OF YOUR LIFEJACKET

Your lifejacket is an important item of technical safety equipment. The working life of the lifejacket will be prolonged if the following instructions are adhered to:

- Check that both status indicators are displaying green.
- Check the expiry date, if any items have expired they **MUST** be replaced before use .
- Refer to pages 9 & 10 – Re-arming your lifejacket for details on how to fit a new capsule.
- Ensure a fully charged cylinder is tightly fitted.
- Ensure that the manual pull toggle is accessible.

IF A RED INDICATOR SHOWS, CHECK THE FOLLOWING ITEMS:

- Ensure a fully charged cylinder is tightly fitted.
- Ensure an automatic capsule is tightly fitted (on Pro-Sensor Automatic).
- Check that the expiry date has not passed and check that there is a plate in the base of the capsule. If there is no plate and a red dot is visible the capsule has been fired and must not be used. See re-arming your lifejacket for how to fit a new capsule onto your operating mechanism.
- Ensure that the manual pull toggle is accessible.

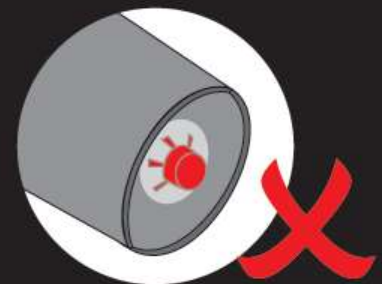

AFTER USE (if Inflated)

- Rinse your lifejacket after use. (Refer to page 28 - Cleaning & Storing Your Lifejacket)
- Re-arming your lifejacket. (Refer to page 11 & 12 - Re-arming Your Lifejacket)

PERIODICAL CHECKS

- A complete inspection of your lifejacket is to be carried out every three months.
- Check the fabric for cuts, tears, abrasion and signs of damage caused by heat.
- Leak testing is an important part of the periodical checks. Inflate your lifejacket orally until firm. Leave overnight or for a minimum of 12 hours. A lifejacket that is leaking will not hold its firmness and must be replaced. Re-pack your lifejacket using the repacking instructions in this manual.

NOTE: Avoid wide variations in temperature when performing this test. Temperature variation can cause the inflatable chamber to loose firmness.



Examine the lifejacket for signs of damage, wear and tear or contamination. Pay particular attention to the webbings and the stitching on your lifejacket.

Perform the oral inflation valve test as follows:

- 1 Fully inflate the lifejacket.
- 2 Place the oral tube into water and check for bubbles.
- 3 If bubbles appear a replacement valve is required.

Check the expiry date on the automatic firing capsule. If it has expired it should be replaced.

(Refer to pages 11 & 12- Re-arming Your Lifejacket)

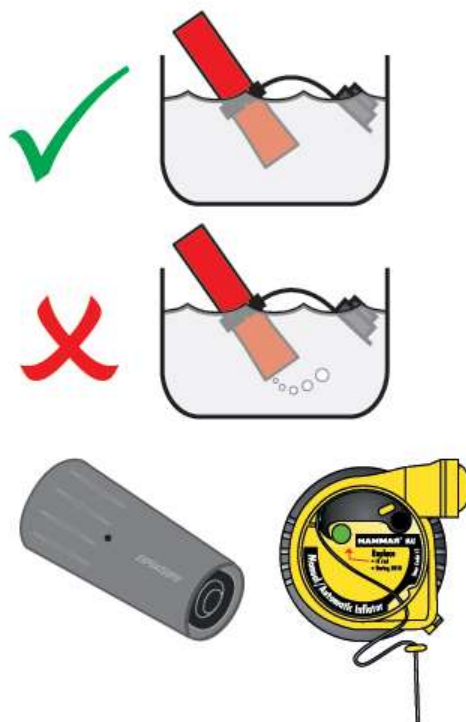

WARNING: If you are not confident in self-inspection of your lifejacket using these instructions, refer to your closest Crewsaver approved service station for details. Crewsaver approved service stations can be found via our website: www.crewsaver.com



CLEANING & STORING YOUR LIFEJACKET

It is important that the lifejacket is stored in a dry, well-ventilated space. If the lifejacket is wet or damp, and it is fitted with an automatic firing capsule, it is advisable to remove the capsule until the lifejacket is completely dry. Any dampness in the lifejacket may penetrate the capsule and eventually cause it to operate the lifejacket. It is advisable to hang the lifejacket to dry on a coat hanger until it is completely dry before stowing. To avoid inflation, do not submerge the lifejacket in water unless the lifejacket has been used or the capsule has been removed.

Periodically rinse the lifejacket in fresh water, particularly if it has been in contact with salt water. Oil and similar marks should be removed by washing with warm soapy water.

Never put your lifejacket in a washing machine, spin or tumble dryer.

After washing always allow your lifejacket to dry naturally before stowing in a dry place.

OTHER IMPORTANT INFORMATION

Your new ErgoFit has been tested to meet a temperature range between -10°C and 40°C as required by BS EN ISO 12402.

- When the temperature is well below freezing, your lifejacket may operate much slower than normal and at very low temperatures a fully discharged cylinder may not adequately inflate your lifejacket. In these temperatures the oral tube should be used for additional topping up if necessary.
- This lifejacket is not a PFD until fully inflated. Full performance may not be achieved using certain clothing or other circumstances. Certain circumstances will alter performance, such as waves or the wearing of garments which provide additional buoyancy. The buoyancy provided by the jacket can be affected if heavy objects are carried in the pockets.
- A whistle is located on the inside right inflation chamber. Six long blasts repeated at intervals is the international distress signal.

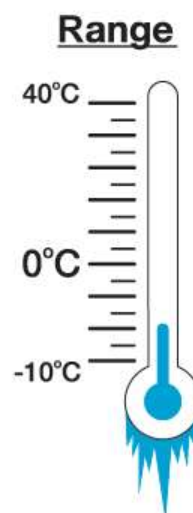

WARNING: Inflating your lifejacket using CO₂ inflation could over pressurise and damage your lifejacket if it has already been orally inflated fully. Do not use as a cushion or in any other way likely to cause damage.



WARNING: This lifejacket is inflated by a CO₂ gas cylinder. Gas cylinders are dangerous goods, and they must be kept away from children and not misused.



FOR USE WITH ERGOFIT
190N LIFEJACKETS

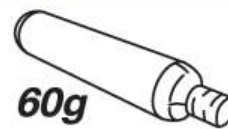

FOR USE WITH ERGOFIT
290N LIFEJACKETS

TESTING YOUR LIFEJACKET

Practice and training are required before use.

In an emergency, there is no time to learn how equipment works. Crewsaver recommend that you try your lifejacket to ascertain its performance before use in an emergency. This will also help familiarise yourself with the product.

When trying out your lifejacket, remember that you may need replacement parts or re-arming kits to get your lifejacket ready for use again.

If you are a weak swimmer it is strongly recommended that you use an automatically operated lifejacket or an inherently buoyant device.

Step 1: Put on your lifejacket by following the donning Instructions.

Step 2: Stand in shallow water or in a swimming pool, ensuring that the water is just deep enough for your head to be above the water's surface.

Step 3: Inflate your lifejacket. This can be done the following ways:

Automatically: If your lifejacket is an automatic it should fully inflate within five seconds of water contacting the automatic firing capsule. (On Hammar jackets the Hammar cap must be at least 20cm below the surface of the water). This activates the operating mechanism and releases the CO₂ cylinder into the lifejacket.

Manually: The lifejacket can be activated manually by a sharp downward pull on the toggle. The lifejacket should fully inflate within 5 seconds.

Oral Inflation: If you are using a pro-sensor automatic lifejacket ensure that the automatic firing capsule has been removed before entering the water. Open the lifejacket cover and locate the oral inflation tube, remove the cap and blow into the tube.

Once inflated see how the lifejacket holds you in the water, noting the position that it holds you in with your mouth well clear of the water's surface and your body at an angle.

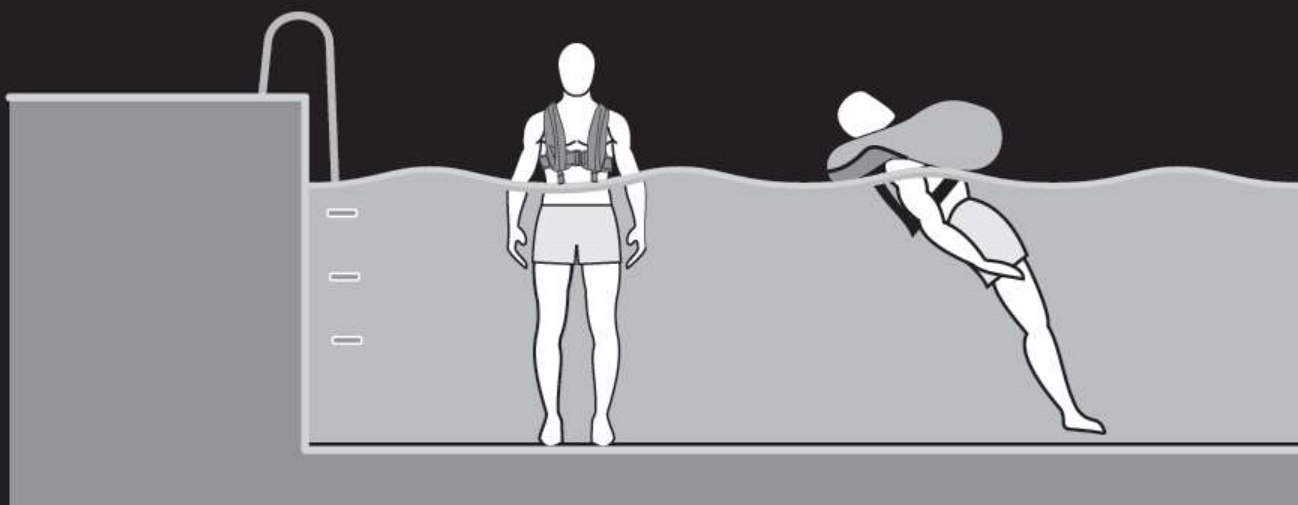

WARNING: Re-arm and re-pack your lifejacket following testing



While in the water it is also recommended that you try out your lifejacket's spray hood.

- 1 Reach above your head and locate the grab loops on the spray hood.
- 2 Pull the hood over your head and loop the straps underneath the ends of Inflatable chamber.

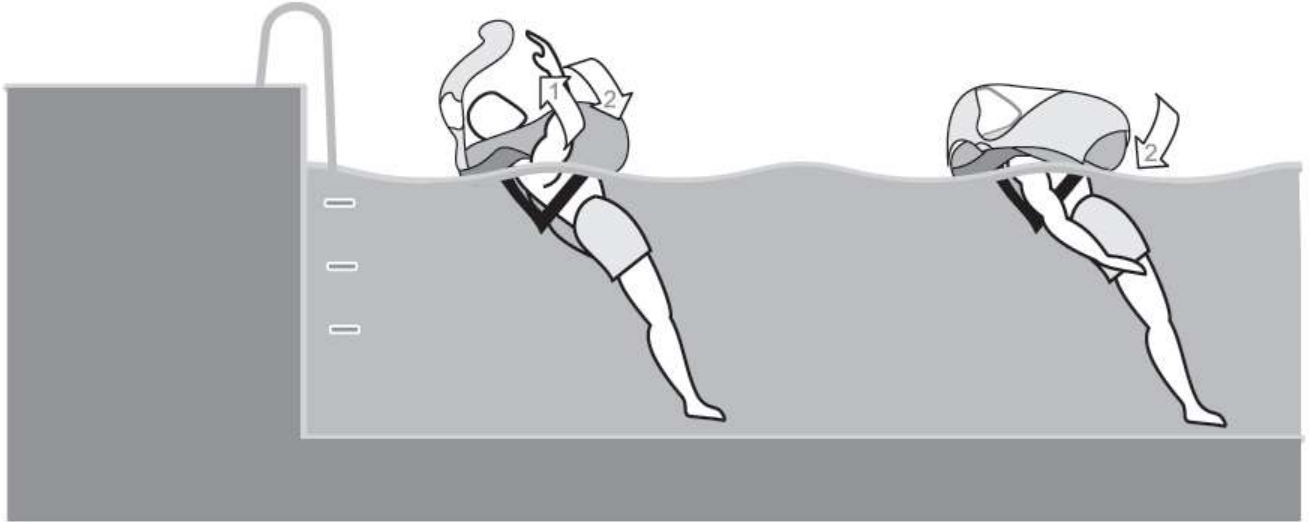

Your lifejacket should be tested whilst wearing any offshore clothing. Check that the lifejacket will turn you from a face down position to a face up position.

NOTE: Some offshore clothing in particular drysuits and immersion suits can trap air - this may affect the performance of the lifejacket. The whistle is located on the oral tube. Six long blasts repeated at intervals is the international distress signal.

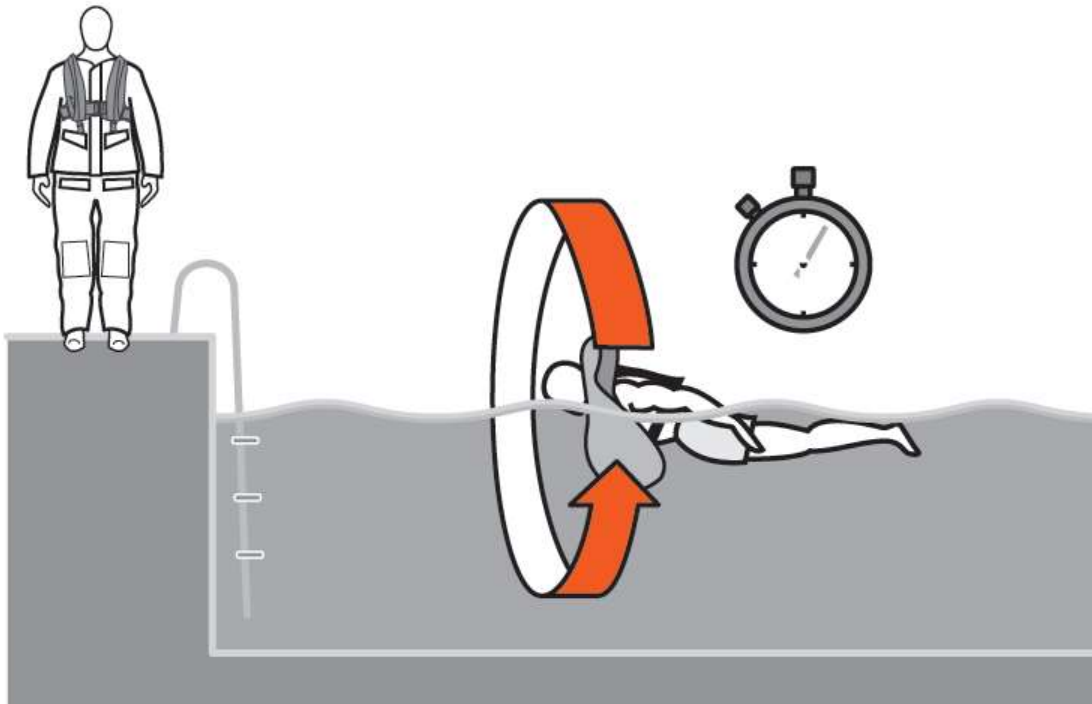

After testing your lifejacket completely deflate the lifejacket using the oral inflation tube. Let the lifejacket dry thoroughly. Do not expose to direct sunlight or heat. Re-arm your lifejacket following the relevant re-arm & re-pack instructions found in this manual.

USING INFLATION TUBE ON INFLATABLE LIFEJACKETS

If required all inflatable lifejackets can be inflated orally without firing the CO₂ cylinder.



WARNING: Inflating your lifejacket using CO₂ inflation could over pressurize and damage your lifejacket if it has already been orally inflated fully.



INFLATING YOUR LIFEJACKET

- 1 Remove the valve cap (a) at the top of the inflation tube (b).
- 2 Blow into the inflation tube. The protective cover on the lifejacket will unfold as the inflation chamber takes shape. To make this easier open up the cover by hand and continue to blow into the tube until it is difficult to inflate further.
- 3 Ensure once inflated that you replace the valve cap (a). It is important to keep this in place, except when the deflation valve is being used

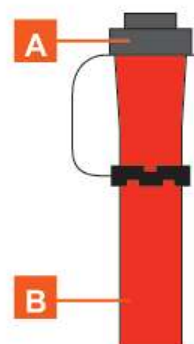

DEFLATING YOUR LIFEJACKET AFTER USE

- 1 Reverse the valve cap (a) at the top of the inflation tube and hold it in the valve.



WARNING: Do NOT use anything other than the valve cap to deflate your lifejacket. Any other item used may cause damage to the valve.



- 2 Squeeze the lifejacket to expel the air inside.



WARNING: If the lifejacket has been inflated using a gas cylinder take care not to inhale the expelled CO₂ gas.



- 3 When as much gas as possible has been expelled, re-inflate the lifejacket orally. This will reduce the concentration of any remaining CO₂.
- 4 Squeeze the lifejacket a second time expelling as much air as possible.
- 5 The lifejacket should now be completely deflated, and can be folded into the cover as before.
- 6 Replace the valve cap (b) back into the normal position on top of the Inflation tube.



WARNING: Over inflation can damage your lifejacket.

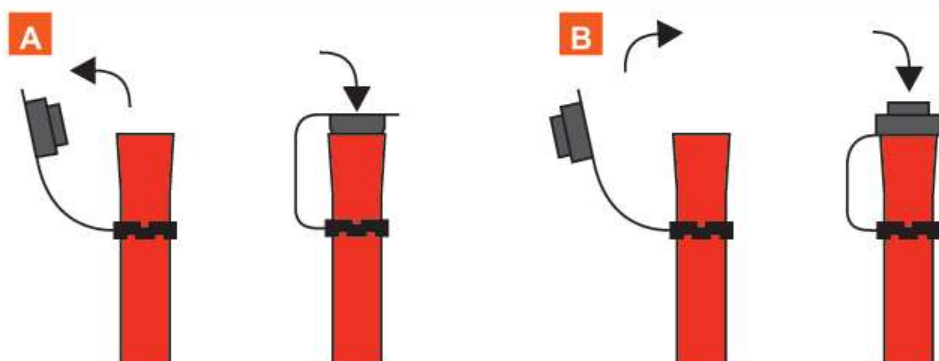

USING SAFETY LINES WITH A HARNESS LIFEJACKET

The ErgoFit range of lifejackets can be used with all approved safety lines.

On lifejackets with a harness, the harness is suitable for an adult wearer.

Crewsaver have a range of safety lines available that can be used with the lifejackets in this manual. Crewsaver currently stock 1 hook, 2 hook and 3 hook lines.

A 1 hook self locking safety line is for children and infants.

A 2 hook safety line is used to connect to a strong point of the boat ensuring that you are attached safely, during adverse conditions.

A 3 hook safety line enables the transfer around the boat without jeopardising safety as a hook can always be attached to a strong point during transfer.



ISO 12401

Deck safety Harness Class 1 0514



WARNING: The deck safety harness and safety line are intended to prevent the user falling overboard. They do not provide protection against falls from a height.



The deck safety harness and safety line may transmit very large forces. Only attach to strong point on the boat. Minimum strength of 1 tonne.

It is unsafe to wear this harness loose. The harness shall be worn tightly in order to be effective.

If your harness and/or safety line are subjected to an exceptional load while worn, it is vital that these are returned to Crewsaver for inspection, even if no external damage is visible.



If using The ErgoFit 190N PRO or 290N EX attach safety hook to BOTH harness loops!

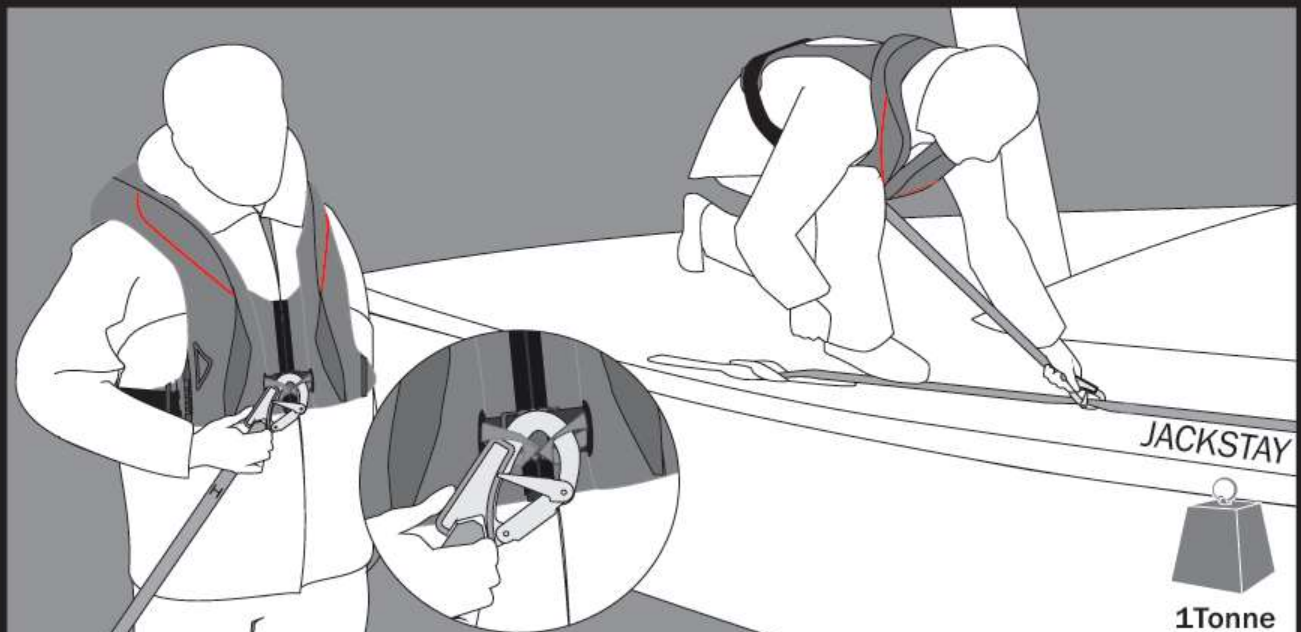

USING SPRAY HOODS WITH YOUR LIFEJACKET

Familiarise yourself with how the spray hood works if needed in an emergency.

- 1 Hood webbing is located at shoulder height on Inflation chamber.
- 2 Pull webbing' up and overhead.
- 3 Secure webbing over the front lobes of the inflation chamber.



CORRECT USE OF LIFTING BECKETS

- 1 Lifting beckets are located in the centre of the inflation chamber.
- 2 Use both lifting beckets to haul casualties from the water.

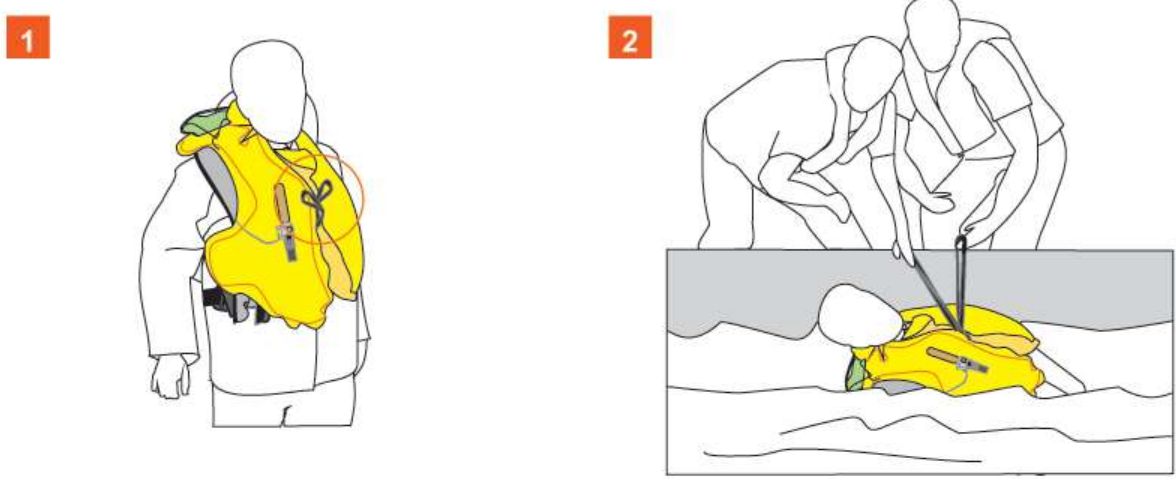

THREADING OF BUCKLES

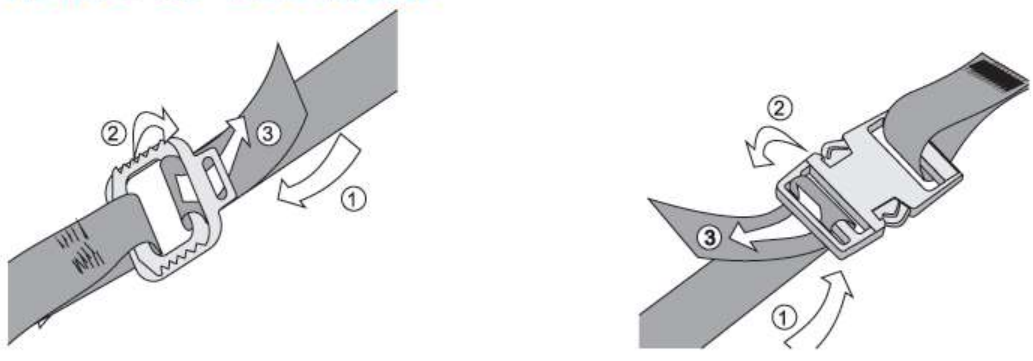

YOUR 3 YEAR GUARANTEE

Crewsaver has 60 years' experience in manufacturing safety equipment and our total commitment to quality enables us to offer you a **FULL 3 YEAR GUARANTEE** on your lifejacket.

This 3 year guarantee includes all parts and labour to repair defective equipment and the return postage.

The guarantee covers all Crewsaver lifejackets and combined lifejackets/harnesses worn for normal leisure purposes. This excludes commercial and industrial use and other applications where equipment is either worn for prolonged periods or in severe conditions.

The guarantee does not cover the effects of accidental damage, normal wear and tear, or mistreatment, or where repairs have been carried out other than by a Crewsaver approved serviced centre.

The guarantee covers all lifejackets registered via the Crewsaver website, any products returned that are not registered with Crewsaver will not be considered for warranty.

Remember your lifejacket is an important piece of safety equipment and should be serviced annually. Servicing should be completed with genuine Crewsaver parts at a Crewsaver approved service station. Crewsaver will not accept any lifejackets for warranty that have not been serviced annually at a Crewsaver approved service station.

Please copy the **Product Serial Number and Date Purchased** below for your own reference:

SERIAL NO: 	DATE PURCHASED:
--------------------	-------------------------

For more information or to register your product please visit our website www.crewsaver.com

SERVICE ANNUALLY

Your lifejacket must be serviced on an annual basis.

Never try to repair a lifejacket yourself. You could cause more damage and render the lifejacket irreparable or affect the warranty.

Always return the lifejacket to a Crewsaver approved service station for repairs and servicing.

To find your nearest Crewsaver approved service station visit: crewsaver.com/findastockist





SIZE

TAILLE

GRÖSSE

MAAT

STØRRELSE

KOKO

STØRRELSE

STORLEK

TAGLIA

TAMANHO



CHEST

TOUR DE POITRINE

BRUSTUMPFANG

BORSTOMVANG

BRYSTVIDDE

**RINTAKEHÄN
YMPÄRYSMITTA**

BRYSTSTØRRELSE

BRÖSTVIDD

MISURE DI PETTO

**TAMANHO DO
PEITO**



WEIGHT

POIDS

GEWICHT

GEWICHT

VEKT

PAINO

VÆGT

VIKT

PESO

PESO



BUOYANCY

FLOTTABILITE

AUFTRIEB

DRIJVERMOGEN

OPPDRIFT

KANTAVUUS

OPDRIFT

LYFTKRAFT

**SPINTA
GALLEGGIANTE**

FLUTUAÇÃO

ART0043 i8

 **survitec**

Crewsaver, Survitec House
Lederle Lane, Gosport
Hampshire
PO13 0FZ
UNITED KINGDOM

Tel: +44 (0) 1329 8200 00
Fax: +44 (0) 1329 2362 18

www.crewsaver.com

RFD AUSTRALIA PTY LTD
PO BOX 6091
SILVERWATER BC 1811

Tel: +61 2 9330 7000
Fax: +61 2 9330 7098



Crewsaver®